

## NEG LOW DROP 5.0V REGULATOR

€ 6,61

Excl. BTW: € 5,46

### Afbeeldingen

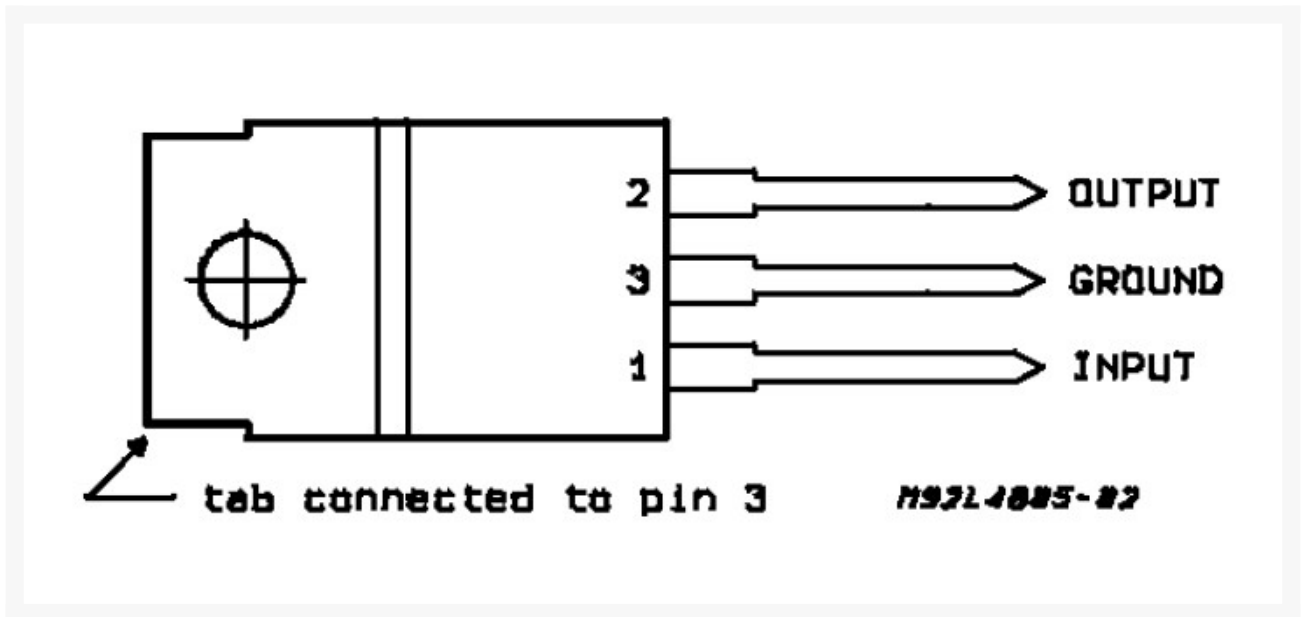

### Beschrijving

L4700 series voltage regulators feature a very low voltage drop (0,6V), an output current of 500mA and a protection against load dump and transients of  $\pm 80V$ , Available in 5V, 8.5V,10V (all  $\pm 4\%$ ,  $T_I = 25^\circ C$ ) these regulators also include reverse polarity protection, overvoltage protection, output current limiting and a thermal shutdown circuit.

## Productinformatie

---

Artikelnummer	L4705
Merk	Merk
Is on Sale	Nee

